

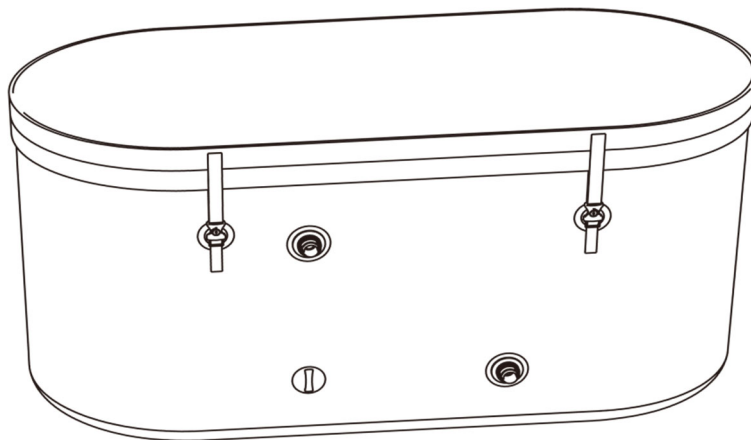

## Inflatable Cold Plunge Tub Assembly Guide



### INTRODUCTION

**Thank you for purchasing this Dynamic Cold Therapy Inflatable Cold Plunge Tub!  
We hope you will enjoy your tub for many years to come!**

To ensure your personal safety during installation and to get the most out of your investment, please read this entire manual before beginning the installation process. If you feel that this process is too difficult to do on your own, we advise that you seek assistance from a local building or home improvement contractor.

**Please note that this manual is for the Plunge Tub only. The User's Manual for the Chiller is separate and will be included with the optional Chiller.**

#### **WARNING:**

**Improper assembly and operation can result in severe personal injury as well as product failure not covered by warranty. Please follow all instructions carefully or contact technical support for assistance.**



## ASSUMPTION OF RISK ACKNOWLEDGEMENT

As a condition of your use of the Dynamic Cold Therapy (the “Company”) website (the “Website”) and purchase of the Company cold plunges and products (the “Products”) you agree as follows under this Assumption of Risk Acknowledgement (the “Acknowledgement”):

**1. Assumption of Risk.** I know and understand the scope, nature, and extent of the risks involved in the use of the Products, including of sudden or prolonged exposure to cold water or heated saunas. (the “Activities”). I understand these risks include, but are not limited to personal injury, damage to property, and/or death. I voluntarily, freely and expressly choose to incur all risks associated with the Activities, understanding that those risks may include personal injury, damage to property, and/or death.

**2. Representations and Warranties.** I represent and warrant that I am of sound body and mind, and in a physical and mental condition capable of handling the conditions that I will encounter during the Activities, that I have read and understood all safety instructions, and that I will comply with all stated and customary terms and included instructions with respect to the Activities and the Products. I further represent and warrant that to the extent I suffer from any physical or mental infirmity, chronic ailment, or injury of any nature, that I have consulted with a medical professional and received clearance to participate in the Activities, and that I recognize and assume the risk of engaging in the Activities in light of my condition.

**3. Governing Law; Arbitration.** I agree that this Acknowledgement will be construed and enforced under the laws of the State of California without regard to its conflict of law’s provisions, as now in effect and as amended in the future. I agree that all disputes arising out of my participation in the Activities must be submitted to binding arbitration in the State of California before an arbitrator chosen by the Company in a proceeding pursuant to that organization’s rules and in accord with its code of ethics. The judgment of the arbitrator will be final and not subject to appeal or review by any judicial or administrative process and may not be vacated. Judgment upon the arbitration award may be entered in any court having jurisdiction thereof. I agree that I may bring claims against the other Parties only in my individual capacity and not as a plaintiff or class member in any purported class or representative proceeding, and that the arbitrator may not consolidate proceedings of more than one person or entity’s claims. In the event of arbitration, the arbitrator will apportion liability for the cost of the arbitrator, other costs, and a reasonable attorney’s fee, in accord with the arbitrator’s rules, this Liability Waiver and Photo Release, and applicable law. In the event a party fails to proceed with arbitration, unsuccessfully challenges the arbitrator’s award, or fails to comply with the arbitrator’s award, the other party is entitled to costs of suit, including a reasonable attorney’s fee, for having to compel arbitration or defend or enforce the arbitrator’s award.

**4. Severability.** I agree that the provisions of this Acknowledgement are severable and in the event any provision is determined to be invalid or unenforceable, the remaining provisions will remain in effect.

**5. Survival.** I agree and acknowledge that the terms and conditions of this Acknowledgement will continue in full force and effect now and in the future at all times during which I participate, either directly or indirectly, in the Activities, and will be binding upon my heirs, executors, administrators, personal representatives, and/or anyone else claiming on my behalf.

**6. Acceptance.** Utilizing the Website, purchasing the Products, or engaging in the Activities pursuant to this Acknowledgement or completing the click-through process required to accept this Acknowledgement will constitute your acceptance to the terms hereof.









---

# IMPORTANT SAFETY INSTRUCTIONS

## SAFETY AND OPERATIONAL WARNINGS

- Before using this product, it is essential to read this entire manual and all instructions. This plunge tub is intended for use solely in the manner described in this manual.
- Carefully inspect your cold plunge tub upon arrival for any signs of damage or leaks before filling it with water. Filling a unit with pre-existing damage can lead to further damage or flooding.
- It is recommended to consult a physician before beginning your cold plunge therapy regiment.
- Please do not leave children unsupervised around the tub. Extreme caution must be exercised to prevent unauthorized access by children. Always lock the tub with the included cover and locking clasps when not in use.
- Pets should be kept away from tub to avoid damage and injury.
- Never operate any electrical appliance when in the tub or when your body is wet. Do not place any electric appliances, such as lights, telephones, radios, or televisions within 5 feet (1.5m) of the tub.
- The use of alcohol, drugs, or medication before or during the cold plunge may lead to loss of consciousness with the possibility of drowning.
- Persons with a history of heart disease, low or high blood pressure, circulatory system problems, or diabetes should consult a physician before they use a Cold Plunge Tub.
- Persons using medication should consult a physician before using a tub since some medication may induce drowsiness while other medication may affect heart rate, blood pressure, and circulation.
- Prolonged immersion in water below 70°F (21°C) can pose a risk of hypothermia. Please note that the core body temperature can continue to drop even after emerging from the cold plunge tub.
- Do not operate tools or heavy machinery or attempt to drive immediately after completing a cold plunge.
- Always enter the cold plunge tub feet first and breathe continuously in a steady, structured rhythm. Do not attempt to hyperventilate or hold your breath while immersed in the tub.
- Exit the tub immediately if there are any feelings of weakness, exhaustion, or being unable to control your fingers, hands, arms, and legs.
- Regularly inspect your cold plunge tub for wear, tear, or damage. Maintain proper maintenance as specified in the User's Manual.

## PACKAGE CONTENTS

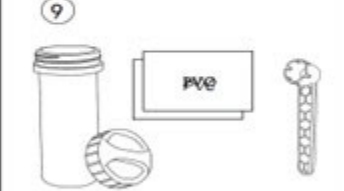
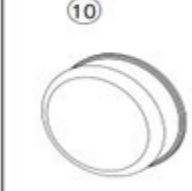
Item	Qty.	Description	Item	Qty.	Description
1	1	Oval Cold Plunge Tub*	7	1	Hand pump
2	1	Oval tub floor mat*	8	2	Inlet/Outlet cap
3	1	Oval locking tub cover*	9	1	Repair Kit
4	1	Circular Cold Plunge Tub**	10	2	Inlet/Outlet cover
5	1	Circular tub floor mat**	*		Only available with Oval Tub
6	1	Circular locking tub cover**	**		Only available with Circular Tub

## Installation

### 1.1 Installation Site Requirements

- Place the tub on a flat, stable surface that can bear the full weight of the tub when filled with water and a person inside. Inadequate structural support may result in personal or property damage.
- Only install your cold plunge tub on a waterproof floor to prevent water damage to your surroundings. Failure to do so may result in property damage.
- Install the unit in a safe location that is not easily accessible to children. Ensure that the unit is out of their reach and properly secured to prevent unauthorized access.
- Please ensure that the installation site provides easy access to a water source and water drainage, and is waterproof. Adequate water access is necessary for filling and maintaining your cold plunge.

## Important Tips:

The ground should be smooth and flat, and there should be no sharp objects. Users should also consider the total weight of the user, tub, and water to ensure that the ground has sufficient strength to support it. Make sure there is a good water source and water drainage system close to the installation area. If the tub is installed in a place that does not meet the safety requirements, then any loss caused will not be covered by the warranty due to improper use by the consumer.

### 1) Indoor installation:

Some special requirements for indoor installation that need attention:

- During the filling and draining of water, water may spill on the ground. We strongly suggest that the tub only be installed near floor drains and on moisture-proof surfaces.
- There should be no items nor appliances that are easily affected or damaged by moisture or water in the immediate area around the tub. To ensure air quality and user comfort, the tub must be installed in a well-ventilated environment.

Note: Do not install the tub on carpets or other surfaces that are easily damaged by water.

### 2) Outdoor installation:

- The ground where the tub is on must be smooth and flat with no sharp objects such as branches and stones nearby. Be sure to use the included floor mat for additional protection.
- Do not expose the tub to direct sunlight for prolonged periods of time. This will shorten the service life of the tub. We recommend covering the tub or placing it in a shaded area when not in use.
- There should be a good water source and water drainage system near the tub.

## 1.2 Tub assembly

Warning: Please only use the included hand pump to inflate the tub and do not over inflate it. Please do not use other electronic or high-pressure air pumps for inflation. The normal working pressure of the tub is 7psi. Excessive pressure will cause the tub to burst or damage the seams of the tub. The maximum pressure for the tub is 9psi.

### Inflation

- Unfold the tub on the ground to inflate it with the included hand pump.
- Open the cap of valve by turning counterclockwise.
- Press the red button in the center of the air valve so that it is in the up position. (fig.2)
- Insert the inflation hose into the air inlet and rotate it clockwise to lock it in place. (fig.1)
- Pump up the tub until the pressure gauge is between 6-8psi.
- Rotate the inflation hose counterclockwise to unlock it from the air valve. There will be a short burst of air that is released.

- Screw the air valve cap on clockwise to lock it in place.

### Deflation

- Open the cap of valve by turning counterclockwise.
- Press the red button in the center of the air valve so that it is in the down position and air starts coming out. (fig.2)



fig.1

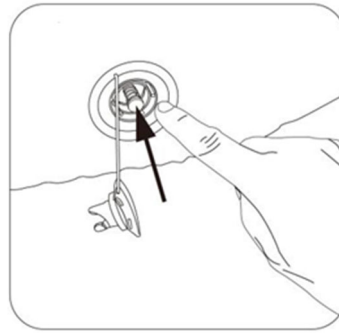

fig.2

Warning: Do not place your face in front of the air valve when pressing down on the red button or releasing air. Do not insert anything into the air valve or obstruct it in any way.

### **1.3 Fill the tub with Water**

Fill the tub with water using a water hose until there is sufficient water to be able to submerge your entire upper body under water. Leave enough room for your head to be fully above the water line. In most cases this would be at about 70% of the plunge pool.

Note: Overfilling the plunge pool will result in water spilling out and over the sides of the pool when you enter. Please be mindful of any electronics, power cords, outlets, etc around the plunge pool. We highly recommend starting with less water and then adding more as needed to submerge your entire upper body.

### **1.4 Combination Locks**

Please lock the combination lock and set the passcode when the tub is not in use.

The lock comes with the default passcode "00" which can be changed. Latch both ends of the lock together and squeeze the sides of the latch. With both sides squeezed in, rotate the number dials to your desired passcode. Once the desired passcode is set, release the sides of the latch to set the code.

## **Tub Maintenance**

### **2.1 Water Maintenance**

We recommend keeping the pH value of the water in the tub between 7.2 and 7.8. A pH value outside of this range can shorten the service life of the tub and cause irritation or damage to your skin. Any

damage to the tub caused by too high or low pH value will not be covered by the manufacturer's warranty. We suggest using pH test paper to routinely test the water quality before using it.

## **2.2 Water Treatment**

It is important to keep the water in the tub clean. The optional Dynamic Cold Therapy Chiller does come with a built-in particle filter and ozonator to keep the water in the tub clean. Please see the User's Manual for usage instructions. If you are not using an external filter and water cleaner, then we suggest the following:

- Cover the tub whenever it's not in use to prevent debris or other particles from falling in.
- Replace the water in the tub every 3 days and then clean the tub with a clean cloth.
- The tub can be treated and disinfected with suitable pool chemicals such as chlorine. Be sure to follow instructions on the packaging of the cleaning agents. Please consult a pool supply store for additional details before use.

Before using pool chemicals, please consult your local pool supply store for additional maintenance information. Pay close attention to and follow the chemical manufacturer's instructions and use chemicals sparingly. Improper use of pool cleaning chemicals resulting in damage to the pool or causing injury will not be covered by the manufacturer or the manufacturer's warranty.

We recommend that you use chlorine reagents as necessary and test the water regularly. Always add the pool chemical to the water and never add pool chemicals to an empty tub.

Note: There are also chlorine free chemicals available. These may be a better option for those with more sensitive skin.

Warning: Let any chemical agents fully dissolve and mix into the water before using the tub. Do not exceed the manufacturer's recommended usage of chemicals in the tub. We do not recommend using harsher chemicals such as bromine in the tub.

## **2.3 Cleaning the Tub**

Dirt from the body and clothes, and contaminants in the water can easily adhere to the surface of tub. It is necessary to frequently wipe down the surface of tub with a soft cloth and a neutral detergent. A fine, soft brush can be used to gently scrub the water inlet and outlet to prevent scaling and calcification to form around the water inlet and outlet.

Note: Do not use hard bristle brushes to clean the surface of the tub.

## **2.4 Tub Repair**

There is an included repair kit with a repair patch, should there be a puncture in the tub causing it to leak air. Before repair, the tub should be drained and deflated, and the damaged section should be wiped clean with some alcohol. Cut the repair patch into an appropriate shape and size. Apply glue directly to the patch and then apply the patch directly over the puncture. We also recommend lightly sanding the area around the puncture before applying the patch so that it will adhere better. If possible,

clamp the patch to tub for maximum adhesion. Let the patch and glue dry for 24 hours before using the tub again.

## 2.5 Tub Storage

Proper care and storage will prolong the service life of the tub. Before storing the tub, completely drain all water from the tub and wipe it down clean with a soft cotton cloth or towel. It is recommended to place the tub in the included storage bag and store it in a cool dry place.

Note: Do not store the tub in an environment below zero degrees Celsius or under direct sunlight for extended periods of time. The tub shell will fade or become brittle and shorten the overall life of the tub. Damage caused by improper storage or care will not be covered by the manufacturer's warranty.

### Warning: Hypothermia Risk in the Cold Plunge

Hypothermia is a serious condition that occurs when the body loses heat faster than it can produce it, causing the core body temperature to drop to dangerous levels. Overexposure to cold water, like in the cold plunge, can increase the risk of hypothermia. It's essential to be aware of the potential dangers and take necessary precautions to ensure your safety.

Water Temperature	Time of Exposure	Potential Symptoms	Expected Time of Survival
Above 70°F (21°C)	Prolonged	Unlikely to cause hypothermia at these temperatures.	N/A
60-70°F (15-21°C)	1-2 hours	Gradual onset of shivering, discomfort.	Negligible
50-60°F (10-15°C)	30-60 minutes	Intense shivering, numbness, reduced coordination. Dizziness may occur.	1-3 hours
40-50°F (4-10°C)	15-30 minutes	Severe shivering, confusion, loss of dexterity. Unconsciousness possible.	30 minutes - 1 hour
32-40°F (0-4°C)	15 minutes or less	Profound shivering, confusion, dizziness, poor judgment, risk of cardiac arrest. Unconsciousness likely.	15-45 minutes
Below 32°F (0°C)	Minutes to seconds	Immediate risk of cold shock, loss of breathing control, cardiac arrest. Survival unlikely.	Minutes to 15 minutes



---

## WARRANTY

DYNAMIC COLD THERAPY warrants that the Cold Plunge Tub, purchased from an authorized agent and in its undamaged original packaging, is free from defects in materials and workmanship. DYNAMIC COLD THERAPY or its agent will, at their discretion, repair or replace parts that become defective within the warranty period, subject to the specific conditions below.

### General Exclusions

- Damage to the finish of any part of the tub
- Fading or discoloration from UV exposure
- Damage from storage in below freezing temperatures
- Damage due to neglect, abuse, incorrect assembly or use of the tub
- Damage due to corrosion or discoloration from lack of water maintenance
- Any charges for freight or customs clearance associated with the return or dispatch of parts
- Any damage to or loss of goods during transport of any kind
- Any labor cost associated with a warranty claim

### General Conditions

- Original proof of purchase must be correctly registered with DYNAMIC COLD THERAPY or one of its appointed distributors
- DYNAMIC COLD THERAPY reserves the right to examine any part where replacement is claimed under warranty
- Warranty period applies only to the original purchaser from the date of purchase and is not transferable
- The product must be returned to your place of purchase in original packaging with transportation, insurance and associated charges paid for by you and risk of loss or damage assumed by you
- DYNAMIC COLD THERAPY makes no other warranties except as stated here and expressly disclaims all warranties not stated in this warranty. Neither DYNAMIC COLD THERAPY nor its associates shall be responsible for incidental or consequential damages
- Manufacturer's warranty automatically commences upon sale of the product to end user and expires upon 1 year (12 months) from the original sale date
- DYNAMIC COLD THERAPY reserve the right to update or modify this warranty as needed.

For warranty-related inquiries, please contact [info@goldendesignsinc.com](mailto:info@goldendesignsinc.com) or (909)-212-5555.