



**DYNAMIC**  
COLD THERAPY

# Cold Plunge Chiller Manual

*Models: .6HP, .8HP, 1HP*



PERSONAL AND COMMERCIAL USE  
120 VAC 15 AMP DEDICATED CIRCUIT WITH GFCI OUTLET REQUIRED

**IMPORTANT: After unpacking (or accidental tip-over allow the chiller to stand upright for 20 minutes before starting. The fluid in the compressor needs to settle. Failure to do so could result in irrevocable damage not covered under warranty.**

Carefully and thoroughly read this owner's manual before operating the system. We highly recommend keeping this manual for regular review.

## PRECAUTIONS:

1. Do not block or obstruct the cooling fans or vents of the chiller. This will affect the operation and efficiency of the chiller and possibly cause damage.
2. It is important to maintain and regularly check and clean the chiller and filter device.
3. To avoid personal injury or damage to the chiller, do not touch the fan during operation.
4. Make sure that the chiller is plugged into a circuit with the properly rated voltage.
5. Do not touch the RCD switch or the electrical components during operation of the chiller.

## CAUTIONS:

- Do not turn the chiller upside down.
- Do not use chiller without the filter element installed
- Please leave 36" or more of space in front of the cooling fan

Working Temperature: 1°C~45°C (34°F~113°F)

Storage Temperature: 10°C~50°C(50°F~122°F)

Storage Relative Humidity: 20%~85%

(Make sure that there is no water in the internal pipeline of the chiller before storage)

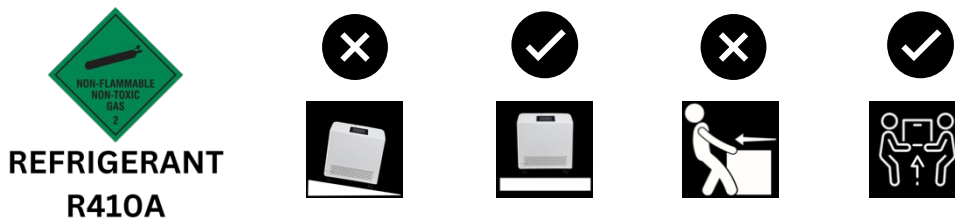



## ASSUMPTION OF RISK ACKNOWLEDGEMENT

As a condition of your use of the Dynamic Cold Therapy (the “Company”) website (the “Website”) and purchase of the Company cold plunges and products (the “Products”) you agree as follows under this Assumption of Risk Acknowledgement (the “Acknowledgement”):

**1. Assumption of Risk.** I know and understand the scope, nature, and extent of the risks involved in the use of the Products, including of sudden or prolonged exposure to cold water or heated saunas. (the “Activities”). I understand these risks include, but are not limited to personal injury, damage to property, and/or death. I voluntarily, freely and expressly choose to incur all risks associated with the Activities, understanding that those risks may include personal injury, damage to property, and/or death.

**2. Representations and Warranties.** I represent and warrant that I am of sound body and mind, and in a physical and mental condition capable of handling the conditions that I will encounter during the Activities, that I have read and understood all safety instructions, and that I will comply with all stated and customary terms and included instructions with respect to the Activities and the Products. I further represent and warrant that to the extent I suffer from any physical or mental infirmity, chronic ailment, or injury of any nature, that I have consulted with a medical professional and received clearance to participate in the Activities, and that I recognize and assume the risk of engaging in the Activities in light of my condition.

**3. Governing Law; Arbitration.** I agree that this Acknowledgement will be construed and enforced under the laws of the State of California without regard to its conflict of law’s provisions, as now in effect and as amended in the future. I agree that all disputes arising out of my participation in the Activities must be submitted to binding arbitration in the State of California before an arbitrator chosen by the Company in a proceeding pursuant to that organization’s rules and in accord with its code of ethics. The judgment of the arbitrator will be final and not subject to appeal or review by any judicial or administrative process and may not be vacated. Judgment upon the arbitration award may be entered in any court having jurisdiction thereof. I agree that I may bring claims against the other Parties only in my individual capacity and not as a plaintiff or class member in any purported class or representative proceeding, and that the arbitrator may not consolidate proceedings of more than one person or entity’s claims. In the event of arbitration, the arbitrator will apportion liability for the cost of the arbitrator, other costs, and a reasonable attorney’s fee, in accord with the arbitrator’s rules, this Liability Waiver and Photo Release, and applicable law. In the event a party fails to proceed with arbitration, unsuccessfully challenges the arbitrator’s award, or fails to comply with the arbitrator’s award, the other party is entitled to costs of suit, including a reasonable attorney’s fee, for having to compel arbitration or defend or enforce the arbitrator’s award.

**4. Severability.** I agree that the provisions of this Acknowledgement are severable and in the event any provision is determined to be invalid or unenforceable, the remaining provisions will remain in effect.

**5. Survival.** I agree and acknowledge that the terms and conditions of this Acknowledgement will continue in full force and effect now and in the future at all times during which I participate, either directly or indirectly, in the Activities, and will be binding upon my heirs, executors, administrators, personal representatives, and/or anyone else claiming on my behalf.

**6. Acceptance.** Utilizing the Website, purchasing the Products, or engaging in the Activities pursuant to this Acknowledgement or completing the click-through process required to accept this Acknowledgement will constitute your acceptance to the terms hereof.

# IMPORTANT INFORMATION

## 1.1 Pre-Install Checklist & Safety Warning

Failure to adhere to the safety instructions and guidelines provided in this warning could result in serious injury or even death. Cold water immersion, electrical installation, and usage entail inherent risks that require careful attention and precautionary measures.

- **Dedicated Breaker:**  
Warning: Use a dedicated circuit breaker for your cold plunge to prevent electrical overload. Consult a licensed electrician to ensure proper installation.
- **GFCI Wall Outlet:**  
Warning: Use a Ground Fault Circuit Interrupter (GFCI) wall outlet for your cold plunge to reduce the risk of electrical shock. Professional electrical installation is advised.
- **Clearance from Walls and Objects:**  
Warning: Do not install the chilling system in closets, cabinets, or other enclosed spaces. Maintain a minimum clearance of 3 feet between all components and utilities of your cold plunge and the nearest walls or objects. Adequate spacing ensures proper ventilation and access for maintenance.
- **Safe Installation Location:**  
Warning: Install the unit in a safe location that is not easily accessible to children. Ensure that the unit is out of their reach and properly secured to prevent unauthorized access.
- **Waterproof Flooring:**  
Warning: Only install your cold plunge and chiller on a waterproof floor to prevent water damage to your surroundings. Failure to do so may result in property damage.
- **Minimum Distance from Outlets:**  
Warning: Maintain a minimum distance of at least 6 feet between your cold plunge unit and the nearest plug or outlet. This prevents potential electrical hazards.
- **Hose Fitting Check:**  
Warning: Before turning on the power, ensure that all hose fittings are properly connected to prevent water leakage that could lead to damage. Failure to do so may result in water damage to your property.
- **Avoid Bending Hose Lines to Prevent Water Flow Restrictions and Freezing:**  
Warning: bending or kinking the hose lines connected to your chiller can lead to serious issues with water flow and potential freezing of pipes within the chiller. It is imperative to handle and route the hose lines carefully to ensure smooth water circulation and prevent damage.
- **Professional Installation**  
We strongly recommend professional installation by licensed experts, particularly for electrical and plumbing components, to ensure compliance with safety codes and regulations.

## 1.2 Sanitation Warning: Safe Use of Ozone

### Important Information about Ozone Use and Safety

Ozone generating systems play a crucial role in water treatment by introducing ozone gas into the water. It's important to understand the characteristics and precautions associated with ozone use to ensure the safety and effectiveness of water treatment processes.

- **Nature of Ozone:**
  - Ozone is a gas composed of three oxygen atoms per molecule and can be readily dissolved in water.
- **Odorless Aqueous Ozone:**
  - When gaseous ozone is dissolved in water, it becomes aqueous ozone, which is odorless.
- **Versatile Benefits:**
  - Ozone serves various purposes, including antimicrobial oxidation for supplemental treatment and secondary disinfection.
  - It aids in the oxidation of organic and inorganic contaminants.
  - Ozone also helps reduce chlorine byproducts and can contribute to algae reduction.
- **Additional Functions:**
  - Ozone can act as a micro-flocculant, aiding in the removal of small particles.
  - It also functions as an anti-foaming agent, helping maintain water clarity.
- **Low Residual Presence:**
  - Ozone leaves little to no residual presence in a pool or spa. Therefore, it is used alongside an EPA-registered primary sanitizer for comprehensive water treatment.
- **Chloramine Control:**
  - Ozone offers the added benefit of destroying chloramines, which are compounds formed by the reaction of chlorine with organic and nitrogenous substances.
  - The use of ozone can lead to reduced chlorine consumption.
- **Compliance with NSF/ANSI Standard 50:**
  - It is essential to comply with industry standards. NSF/ANSI Standard 50 mandates the use of ozone in conjunction with chlorine for water treatment.

### Safety Precautions:

- Ozone generators should be installed, operated, and maintained by trained professionals.
- Always follow manufacturer instructions for the safe use of ozone-generating systems.
- Regularly monitor and maintain ozone levels to ensure effective water treatment.
- Avoid direct inhalation of ozone gas, as it may have adverse health effects.
- Educate all personnel involved in water treatment about ozone safety practices.

### \*\*Additional Warning:

- **Regular Ozone Tubing Inspection:**
  - Regularly check ozone tubing to ensure it is intact and without breaches.
  - Any breaching or damage to ozone tubing can lead to the release of ozone gas, which is dangerous when inhaled.
  - Breaches in tubing may cause harm due to the potential release of ozone into the air.

## 1.3 Electrical Warning

**Important:** The following electrical warning is intended to minimize electrical risks associated with the installation and use of your DCT Chiller. Please note that electrical codes and safety practices can vary based on your location. It is essential to follow the latest local electrical codes and regulations to ensure a safe installation. We highly recommend consulting a licensed electrician who is familiar with your area's codes and requirements for pools and spas.

### **Electrical Codes and Requirements:**

- Follow the latest applicable electrical codes for pools, spas, and similar water-related installations in your region. Compliance with these codes is critical to preventing electrical hazards.
- Codes such as the National Electrical Code (NEC) in the United States and the International Electrotechnical Commission (IEC) standards for other countries often provide guidelines specific to pools and spas.

### **Electrical Outlet Selection:**

- Use a Ground Fault Circuit Interrupter (GFCI) wall outlet for your cold plunge to minimize the risk of electrical shock.
- Ensure that the outlet is rated for outdoor and wet locations. GFCI outlets are designed to detect imbalances in electrical current, providing an added layer of safety.

### **Dedicated Breaker and Wiring:**

- Install a dedicated circuit breaker for the cold plunge to prevent electrical overload. The amperage and wiring requirements should be determined by a licensed electrician based on the manufacturer's specifications and local codes.
- NEC Article 680 outlines guidelines for wiring and electrical equipment used in swimming pools, spas, hot tubs, and similar installations.

### **Minimum Distance from Outlets:**

- Maintain a minimum distance of at least 6 feet between the cold plunge unit and the nearest plug or outlet. This distance helps minimize the risk of accidental contact with water and electrical components.

### **\*\*Important Note**

This product has the potential to cause death, injury, harm, or property damage if not installed, operated, and maintained in strict accordance with the provided instructions, local regulations, and up-to-date electrical codes. The risks associated with improper electrical installation and usage are substantial and could have severe consequences. We emphasize the necessity of engaging a licensed electrician experienced in pool and spa installations to ensure compliance with the latest codes and regulations, as well as to safeguard against electrical hazards.

## 1.4 Specs

| <b>Model</b>                             | <b>.6HP</b>  | <b>.8HP</b>  | <b>1HP</b>   |
|--|--|--|--|
| <b>Power Supply</b>                      | AC 120V<br>60Hz  | AC 120V<br>60Hz  | AC 120V<br>60Hz  |
| <b>Input Power</b>                       | 640W   | 725W   | 1500W  |
| <b>Compressor Power</b>                  | 505W   | 630W   | 945W   |
| <b>Cooling Capacity</b>                  | 1680W  | 2230W  | 2700W  |
| <b>Heating Function</b>                  | Yes  | Yes  | Yes  |
| <b>Refrigerant</b>                       | R410A  | R410A  | R410A  |
| <b>Water Temp.</b>                       | 37°F-85°F  | 37°F-85°F  | 37°F-85°F  |
| <b>Disinfection</b>                      | Built-in ozone pump<br>Built-in self-priming<br>system | Built-in ozone pump<br>Built-in self-priming<br>system | Built-in ozone pump<br>Built-in self-priming<br>system |
| <b>Circulation Pump</b>                  |  |  |  |
| <b>Water Filter</b>                      | 20 Micron 5" x 2.5"                                    | 20 Micron 10" x 2.5"                                   | 20 Micron 10" x 2.5"                                   |
| <b>WIFI Remote Control</b>               | Android & IOS App                                      | Android & IOS App                                      | Android & IOS App                                      |
| <b>Transport Wheels</b>                  | Yes  | Yes  | Yes  |
| <b>Carry Handle</b>                      | Reinforced Steel                                       | Reinforced Steel                                       | Reinforced Steel                                       |
| <b>Quick Connectors</b>                  | 1/2" Threaded NPT                                      | 1/2" Threaded NPT                                      | 1/2" Threaded NPT                                      |
| <b>Net Weight</b>                        | 66 lbs.  | 77 lbs.  | 88 lbs.  |
| <b>Dimensions</b>                        | 17"x 11"x 19"  | 19"x 14"x 21"  | 22"x 16"x 22"  |
| <b>Certifications</b>                    | CE   | CE   | CE   |
| <b>Cooling Time (For Reference Only)</b> | 1-3°F Every 60 Minutes                                 | 1-3°F Every 40 Minutes                                 | 1-3°F Every 20 Minutes                                 |

# ASSEMBLY

## 2.1 Product Diagram

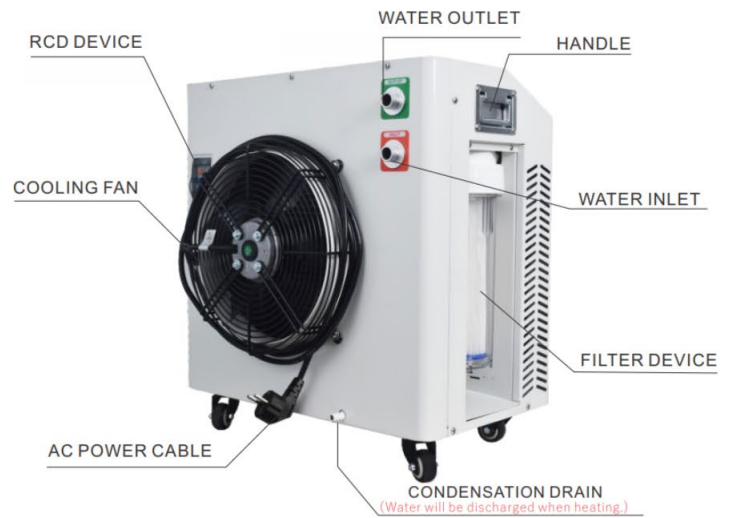
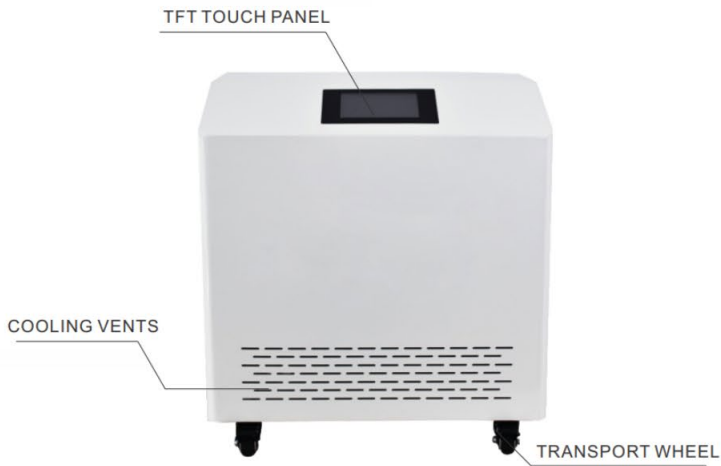
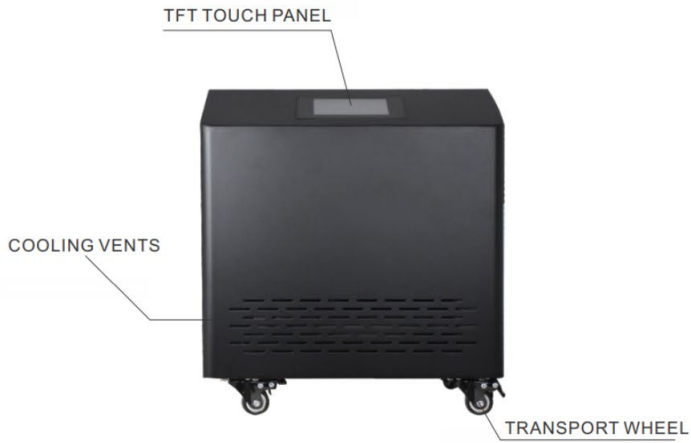



## 2.2 Packing List

1pc Cold Plunge Chiller & Spa System

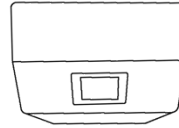

1pc Filter Wrench



1pc Hair Strainer Wrench



3pc 20 Micron Filter Cartridge

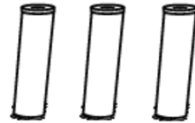

2pc Quick-Connect Hoses

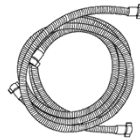

2pc Hose Adapters



6pc Rubber Gasket Seals



Note: Your cold plunge has been assembled and tested prior to packaging.

## 2.3 Assembly Details

### Step 1: Find a level surface for your chiller

**IMPORTANT:** Allow the chiller to stand upright on a level surface for 20 minutes before starting. The fluid in the compressor needs to settle. Failure to do so could result in irrevocable damage not covered under warranty.

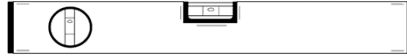

### Step 2: Apply teflon tape

- Wrap Teflon tape clockwise 3x around the threads of both the inlet/outlet of the plunge bath, chiller, and valves.

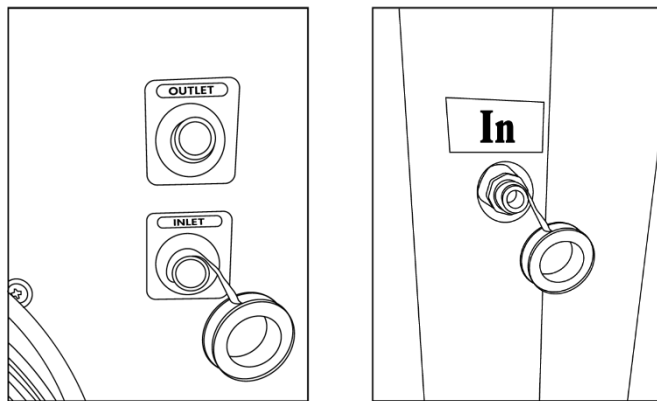

### Step 3: Connect your chiller to your plunge

**IMPORTANT:** Make sure the gasket is properly in place on your hose before connecting.

- Connect the "INLET" on your chiller to the "OUT" on your plunge bath with a quick-connect hose.
- Connect the "OUTLET" on your chiller to the "IN" on your plunge bath with a quick-connect hose.
- Hand tighten only.

**NOTE:** Once the hoses are attached you may fill your cold plunge bath.

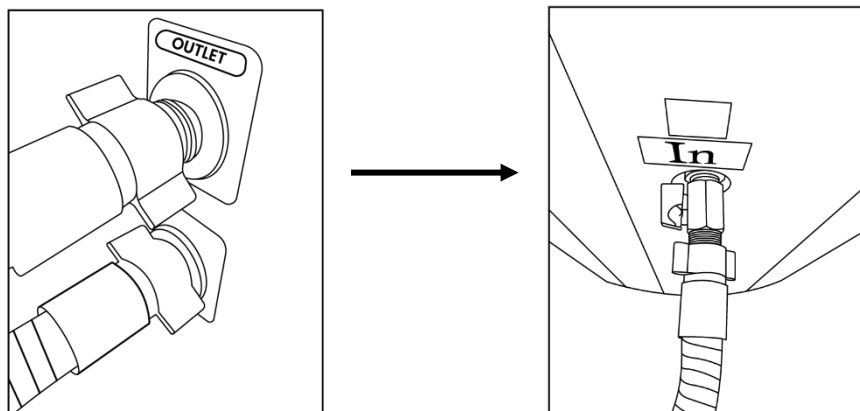

## 2.4 Assembly Diagram

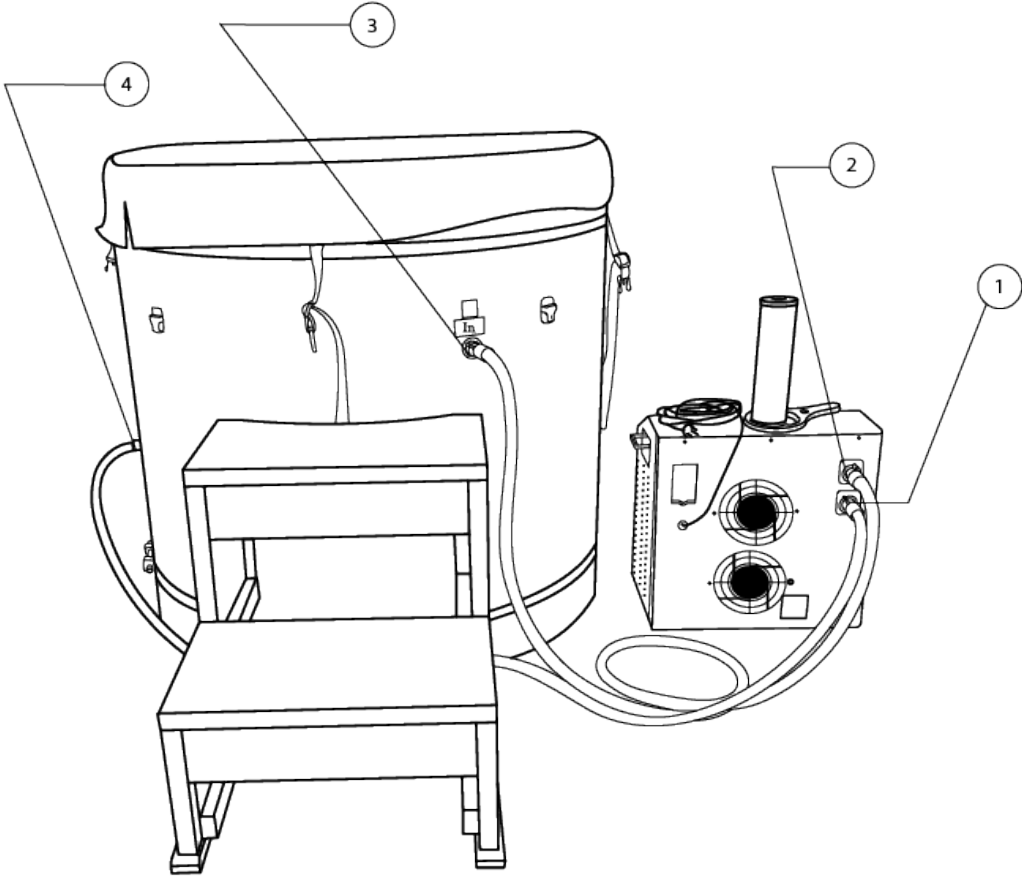

| No. | Name           | No. | Name               |
|-----|----------------|-----|--------------------|
| 1   | Chiller Inlet  | 3   | Cold Plunge Inlet  |
| 2   | Chiller Outlet | 4   | Cold Plunge Outlet |

# OPERATING THE COLD PLUNGE CHILLER & SPA SYSTEM

## 3.1 Control Panel Introduction

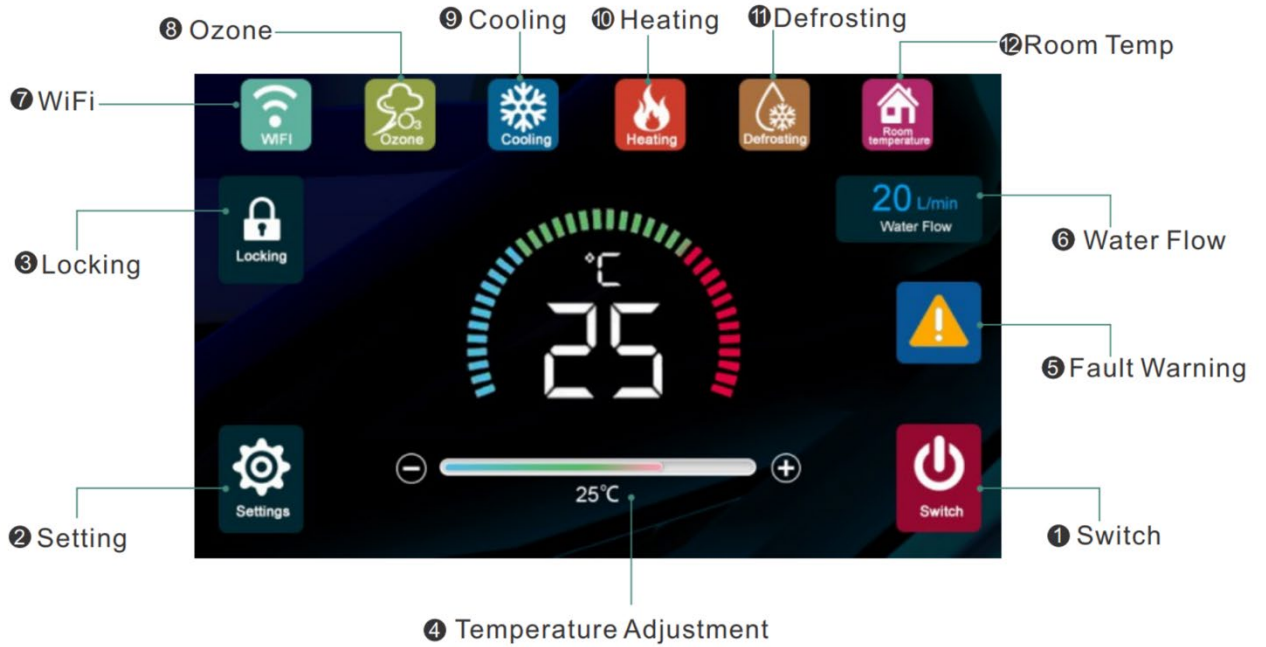

## 3.2 Interface Overview

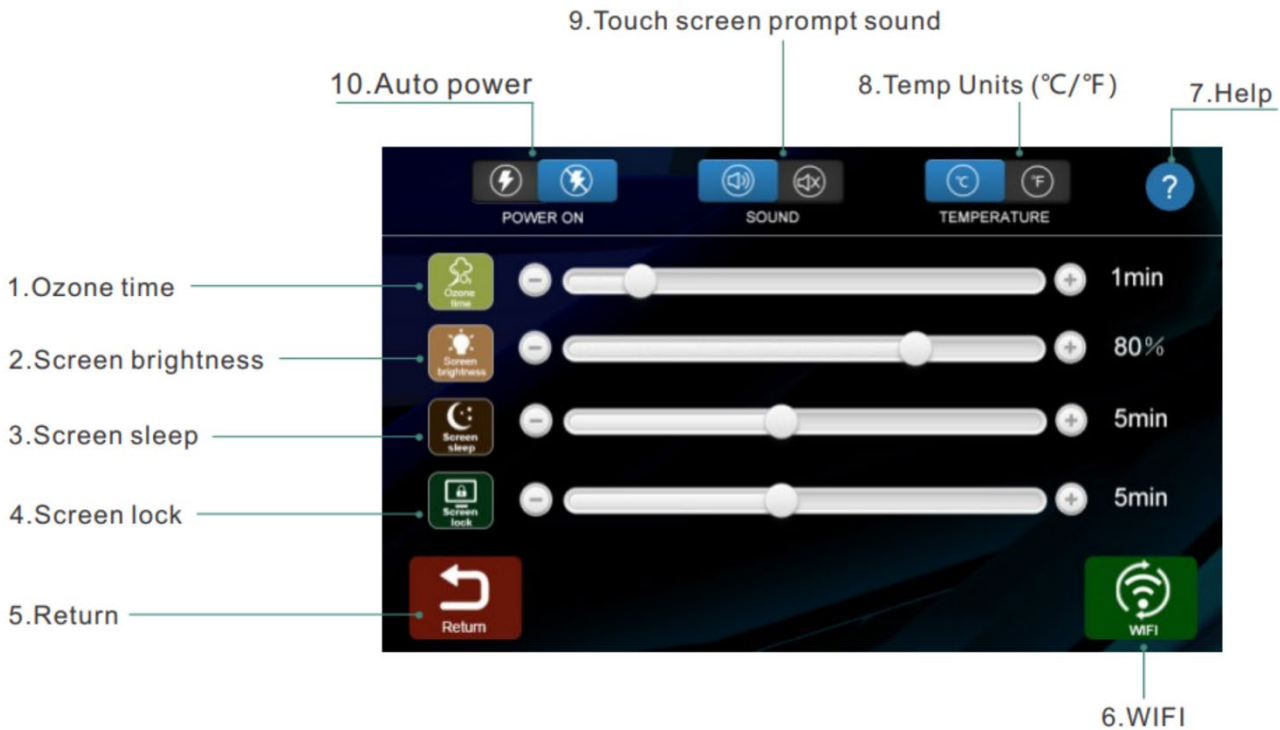

### 3.3 App Set Up

Note: Tuya can only support 2.4G WIFI signal. Before connecting your phone to the chiller, please confirm that the Wi-Fi\_\_33 used by your phone is in the 2.4G frequency band. It will not be able to connect to the chiller, if it is in the 5G frequency band.



Scan to  
Download Tuya  
Smart app

#### Step 1: Add your chiller

- Turn on your chiller.
- Download the Tuya app.
- Go into the settings menu on your chiller.
- Press and hold the WIFI button for 3-5 seconds until the button begins to blink.
- Tuya should locate the chiller automatically.
- Enter your WIFI password.

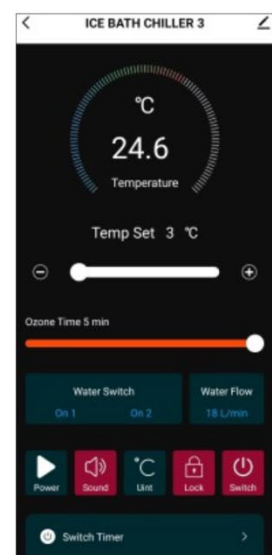
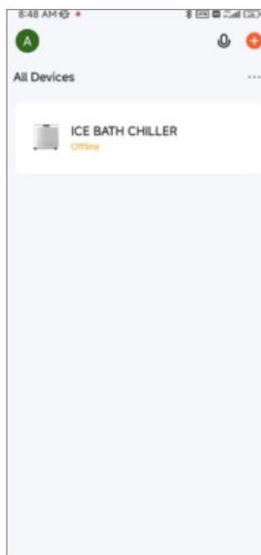

## 3.4 Settings & Preferences

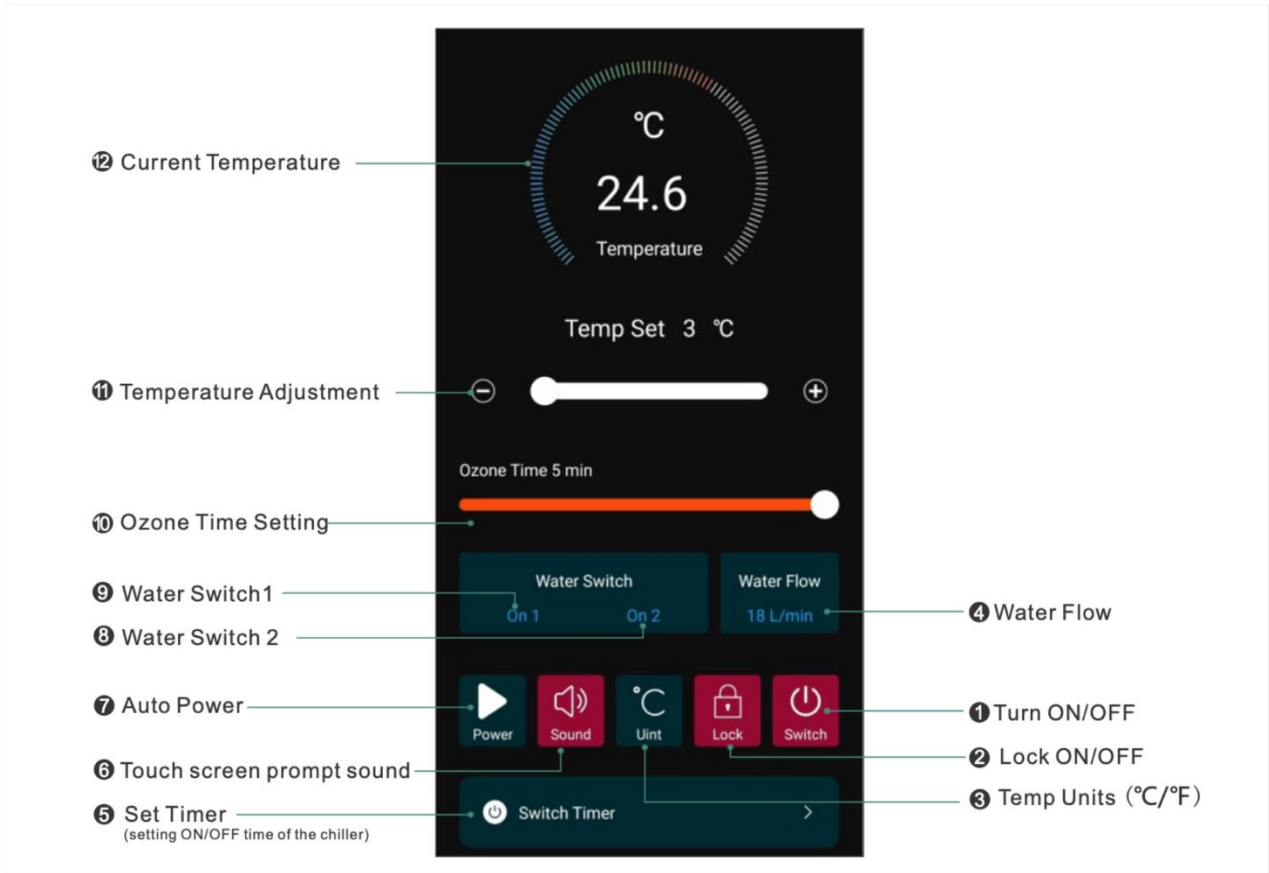

### Step 1: Test your GFCI (reset) button

- Locate the GFCI reset button on the back of your chiller.
  - After the unit is turned on, hit the reset button.
  - Test to make sure the unit properly shuts down / reboots.
- IMPORTANT: If the unit does not reset. Shut the unit off and contact support immediately.**

### Step 2: Set a timer

- We highly recommend setting your chiller on a timer. Reducing the runtime will dramatically improve the lifespan of your chiller. We recommend scheduling 8 hours of downtime per day.

### Step 3: Turn on Auto Power

- This ensures your chiller will automatically maintain the set temperature.

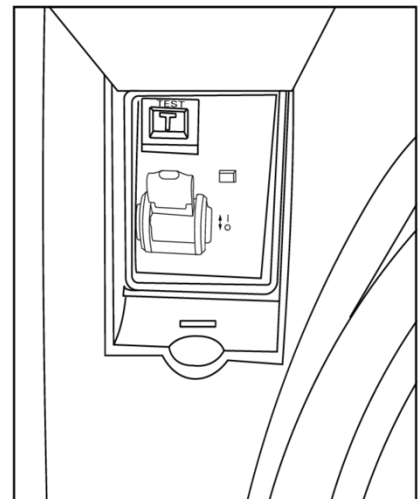

## 3.5 Water Maintenance

### Step 1: Filling your plunge

- For best results, it's recommended that you fill your plunge with filtered water. In-line water hose filter attachments are readily available at local hardware stores, pool supply stores, and online at Amazon.

### Step 2: Turn on your ozone

- It's recommended that you set your ozone pump to run for 2 minutes – 5 minutes minimum. This frequency will efficiently help sanitize the water in your plunge.

Note: The effectiveness of ozone is dependent on balanced water. If the water in your plunge has unbalanced pH or Alkalinity your ozone will become less effective.

### Step 3: Treat your water

IMPORTANT: Leaving your water untreated can cause rapid erosion to the system and is not covered under warranty. Additionally, it's incredibly harmful to the skin to bathe in corrosive water.

- Add a 1 tsp of spa shock oxidizer granular (or the recommended ppm of liquid, tablets, or other oxidizer form).
- Wait 15 minutes.
- Test your water. Use a test strip following instructions on bottle.
- Ideal Total Alkalinity Range: 125-150 ppm
- Ideal pH is between 7.2 and 7.8.
- Adjust your water using Alkalinity and/or pH increaser/decreaser.
- Wait 15 minutes before making any adjustments.
- Adjust 1 tsp at a time and retest after 15 minutes. Repeat until you have the ideal results.
- We highly endorse using a water conditioner after balancing your water. This will lock in your pH & Alkalinity levels for extended periods of time.
- Test your water daily and adjust as needed.

### Step 4: Change your filter

IMPORTANT: It's recommended that you change your filter every 20 plunges, or as needed.

- Turn your pump off.
- Close your inlet/outlet valves on your plunge.
- Use the filter wrench to unscrew the filter housing.
- Dispose of the old filter.
- Replace with a new filter, then screw filter housing back on.

NOTE: Make sure the gasket on the filter housing is properly in place before screwing the filter housing back on. Failure to do so could result in water damage when turning the chiller back on.

### Step 5: Test your water

- It's recommended that you test your water daily, or as needed.
- It's recommended that you contact your local pools & spas dealer to complete a comprehensive lab water test and chemical maintenance protocol.

### Step 6: Change your water

- It's recommended that you change the water in your tub weekly, or as needed.
- Once your water is foggy or highly unbalanced, you must change the water immediately.

## 3.6 Unit Maintenance

### Maintenance Checklist:

- **Regular cleaning:**
  - Wipe down the exterior and fan regularly to prevent dust and debris from entering the system.
  - We highly endorse getting a small water vacuum to clean debris, especially for outdoor units.
  
- **Pump inspection:**
  - Periodically inspect the pump for any signs of damage or abnormal noise. If it becomes noisy, or triggers a water flow malfunction, it's likely time to replace your filter.
  
- **Hose and fitting examination:**
  - Inspect hose connections and fittings for leaks or damage. Tighten or replace as necessary.
  
- **Water level maintenance:**
  - Maintain the appropriate water level to ensure proper circulation and prevent damage to the chiller.
  
- **Winterization (if applicable):**
  - Properly winterize the chiller if used in cold climates, to prevent freezing and damage during winter months.
  - IMPORTANT: Freezing parts are not covered under warranty.



## 3.7 Troubleshooting

### My chiller won't turn on

- Try hitting the reset button on your GFCI adapter on the back of your chiller.
- Try resetting your GFCI outlet.
- Check the breaker in your home.

### Water flow failure

- Replace your filter. When the filter is clogged it will often trigger this failure.
- Clean your hair strainer. Make sure that the hair strainer is not clogged.

### My chiller keeps turning off

- Make sure your reset button isn't in a high traffic area, where it may be getting accidentally pushed.
- Check your breaker. Make sure you are on a dedicated 15AMP breaker switch.
- Check your electrical box for any moisture.
  - If moisture is discovered in the electrical box it could be one of two things:
    1. There is a breach in your electrical box somewhere. Check for damage or improper seal when it's closed or cracks in the box.
    2. The check valve on your ozone tubing has failed. This would allow a small amount of water to enter the electrical box and would trigger your GFCI to shut the system off. If you see water coming through the small 1/4" clear tubing and entering your electrical box, turn off your unit and reach out to Dynamic Cold Therapy for a replacement part.

### My chiller is leaking

- It's likely condensation. A small puddle of condensation is to be expected daily. It's best to wipe it down once per day to avoid moisture buildup.
- Test to see if the water level is getting lower in your plunge tub. Mark it and check again the next day
- If your leak is significant, please reach out to Dynamic Cold Therapy customer service directly.

# Warranty Information

## COLD PLUNGE CHILLER WARRANTY

DYNAMIC COLD THERAPY warrants that the Cold Plunge Tub, purchased from an authorized agent and in its undamaged original packaging, is free from defects in materials and workmanship. DYNAMIC COLD THERAPY or its agent will, at their discretion, repair or replace parts that become defective within the warranty period, subject to the specific conditions below.

### General Exclusions:

- **Temperature Limitation:** This warranty does not cover any damage caused by using the Chiller in freezing temperatures at or below 32° Fahrenheit.
- **Water Chemistry Maintenance:** This warranty does not cover any damage or corrosion caused by not maintaining proper water chemistry or failing to regularly change out water.
- **Visible Damage upon Delivery:** This warranty does not cover any damage to or loss of goods during transport of any kind.
- **Regular Maintenance:** This warranty does not cover any damage caused by neglecting to perform proper maintenance on the Chiller and its components.
- **Labor:** This warranty does not cover any labor cost associated with a warranty claim.
- **Non-Transferable:** This warranty is non-transferable and applies only to the original purchaser.

### General Conditions:

- Original proof of purchase must be correctly registered with DYNAMIC COLD THERAPY or one of its appointed distributors
- DYNAMIC COLD THERAPY reserves the right to examine any part where replacement is claimed under warranty
- Warranty period applies only to the original purchaser from the date of purchase and is not transferable
- The product must be returned to your place of purchase in original packaging with transportation, insurance and associated charges paid for by you and risk of loss or damage assumed by you
- DYNAMIC COLD THERAPY makes no other warranties except as stated here and expressly disclaims all warranties not stated in this warranty. Neither DYNAMIC COLD THERAPY nor its associates shall be responsible for incidental or consequential damages
- Manufacturer's warranty automatically commences upon sale of the product to end user and expires upon 1 year (12 months) from the original sale date

Dynamic Cold Therapy reserves the right to update or modify this warranty as needed.

For warranty-related inquiries, please contact [info@goldendesignsinc.com](mailto:info@goldendesignsinc.com) ; (909)212-5555