



Installation, Operation & Maintenance Manual

iTEMPO™ & iTEMPOPLUS™ CONTROLS

mr.steam® | Feel Good Inc.

www.mrsteam.com

When installing and using this electrical equipment, basic safety precautions should always be followed, including the following:

IMPORTANT SAFETY INSTRUCTIONS

1. READ AND FOLLOW ALL INSTRUCTIONS

2. **⚠️WARNING** Do not permit children under the age of 16 to use this steambath.
3. **⚠️WARNING** Steam is hot and can cause injury or death if improperly used. Steam rooms contain steam and elevated temperatures. Please read and observe all warnings in this manual before installing or using a steam room.
4. **⚠️WARNING** To reduce the risk of injury:
 - A. The wet surfaces of steam enclosures may be slippery. Use care when entering or leaving.
 - B. The steam head is hot. Do not touch the steamhead and avoid the steam near the steamhead.
 - C. Prolonged use of the steam system can raise excessively the internal human body temperature and impair the body's ability to regulate its internal temperature (hyperthermia). Limit your use of steam to 10-15 minutes until you are certain of your body's reaction.
 - D. Excessive temperatures have a high potential for causing fetal damage during the early months of pregnancy. Pregnancy or possibly pregnant women should consult a physician regarding correct exposure.
 - E. Obese persons and persons with a history of heart disease, low or high blood pressure, circulatory system problems, or diabetes should consult a physician before using a steambath.
 - F. Persons using medication should consult a physician before using a steambath since some medication may induce drowsiness while other medications may affect heart rate, blood pressure and circulation.

HYPERTHERMIA occurs when the internal temperature of the body reaches a level several degrees above the normal body temperature of 98.6° F. The symptoms of hyperthermia include an increase in the internal temperature of the body, dizziness, lethargy, drowsiness, and fainting. The effects of hyperthermia include:

- a) Failure to perceive heat;
- b) Failure to recognize the need to exit the steambath;
- c) Unawareness of impending risk;
- d) Fetal damage in pregnant women;
- e) Physical inability to exit the steambath; and
- f) Unconsciousness.

⚠️WARNING

The use of alcohol, drugs, or medication can greatly increase the risk of hyperthermia.

SAVE THESE INSTRUCTIONS

READ ME FIRST!

⚠️ WARNING As you follow these instructions, you will notice warning and caution symbols. This blocked information is important for the safe and efficient installation and operation of this generator. These are types of potential hazards that may occur during installation and operation:

⚠️ WARNING Indicates a potentially hazardous situation, which, if not avoided, could result in death or serious injury.

⚠️ CAUTION Indicates a potentially hazardous situation, which, if not avoided may result in minor or moderate injury or product damage.

IMPORTANT NOTE: This highlights information that is especially relevant to a problem-free installation.

All information in these instructions is based on the latest product information available at the time of publication. Sussman-Automatic Corporation reserves the right to make changes at any time without notice.

Table of Contents:

Important Safety Instructions.....	2
Before Installing.....	4
Dimensional Information	5
Installations.....	6-8
Installing the Remote Temperature Probe	9-11
iTempo Operating Instructions	12-13
iTempoPlus Operating Instructions.....	14-17
Care and Maintenance	18
Warranty	18
Template for Control Installation.....	19

BEFORE INSTALLING

Carefully inspect the control and packaging for shipping damage. In the event of shipping damage, please contact the carrier for claim information. Our customer service department can assist you with any missing or damaged parts.

⚠CAUTION To avoid unintentional steambath operation, do not locate the control where other controls, accessories, shower heads, valves, body sprays or similar within the shower could cause confusion or interfere with the Mr.Steam® control's intended use and function. Do not use any iTempoPlus™, iTempo™, HomeWizard™ or iGenie® controls without reading and understanding the respective Installation and Operation Manual and Mr.Steam steam generator Installation and Operation Manual (PN 101289 Revision number 10.0/08 or higher). Failure to read and understand these instructions may result in an inoperative or hazardous installation.

⚠WARNING A peel and stick warning sticker is provided in the Mr.Steam steam generator Installation, Operation and Maintenance Manual. This manual is provided with every steam generator. The warning sticker must be read and permanently affixed in a conspicuous location near the steam room. Failure to read and affix this warning sticker in a conspicuous location may result in serious injury or death. Please call Mr.Steam at 800 767-8326 for a free replacement or if you have any questions regarding the warning sticker. Install the iTempo or iTempoPlus controls according to installation instructions. Failure to install according to instructions will result in an inoperative control or hazardous overheating or inadequate heating of the steam room. If an iTempo or iTempoPlus control is installed outside the steam room a Remote Temperature Probe (PN MST5) must be installed inside the steam room

per instructions for the Remote Temperature Probe. Failure to install according to instructions will result in an inoperative control and overheating of the steam room.

⚠WARNING Do not route iTempoPlus, iTempo, Home Wizard or iGenie control wiring inside conduit together with power lines or close to hot water or steam piping. Doing so may result in an inoperative or hazardous installation.

⚠WARNING Do not alter or modify any Mr. Steam product. Doing so may result in an inoperative or hazardous installation and will void the warranty.

IMPORTANT NOTES:

- Turn power to the steam generator OFF before connecting the control to the generator. Failure to turn the power off will result in an inoperable control.
- Do not operate iTempoPlus, iTempo, Home Wizard or iGenie controls with anything other than a Mr.Steam iTempo compatible steam generator. Mr.Steam residential steam generators with serial numbers lower than 900000, or any other brand of steam generator are not to be operated with iTempo controls. Doing so may result in an inoperative installation.
- This document contains important safety, operation and maintenance information. Leave this document with the homeowner. Do not discard this document.
- Discontinue use of the steam generator or control if the steam generator is damaged or otherwise not functioning properly. Doing so may result in an inoperative or hazardous installation.
- All illustrations are for illustrative purposes only.

Dimensional Information for the Round and Square iTempo™ and iTempoPlus™

BOX CONTENTS:

- iTempo™ or iTempoPlus™ Control
- Control Cable (30 ft.)
- Steam head
- Tube of Silicone Sealant
- Owner's Manual

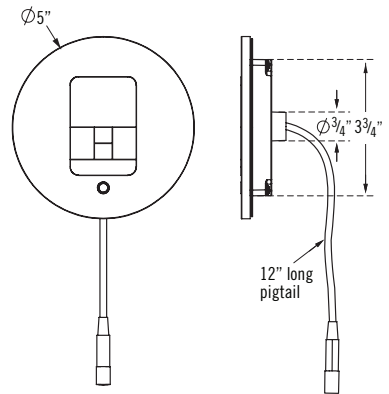
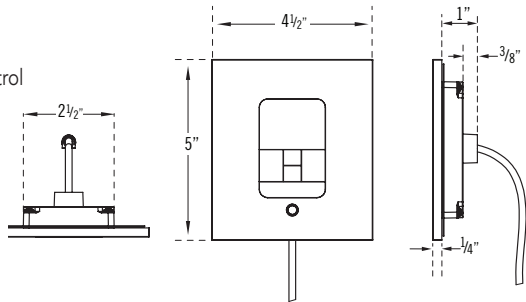

Drawings for Illustrative Purposes Only.

Installation Instructions for Round & Square iTempo™ and iTempoPlus™

STEP 1

Determine the desired installation location of the control. The iTempo™ and iTempoPlus™ controls are designed to be installed inside or outside the steam room as a matter of personal preference. If the control is installed outside the steam room a Remote Temperature Probe must be installed inside the steam room. If the control is installed inside the steam room the control must be located:

- 4-5 feet above the floor near the bather seating area.
- The control features an integral temperature sensor. Locate the control in a location representative of the desired steam bathing temperatures. Do not locate the control above or near the steam head or direct steam emissions. Locating the controls near the steamhead or near direct steam emissions may result in poor steam room temperature control.
- On a vertical wall
- The control cable length is 30 feet. Insure that the control and/or steam generator are located accordingly. Contact a Mr.Steam technical service representative if a longer cable is required (60 ft. cable, PN 103990-60).

IMPORTANT NOTE: The control cable should be run in a dedicated 1" conduit to facilitate installation and service.

IMPORTANT NOTE: See installation instructions for the MSTs Temperature Probe before rough-in or installation of control (pgs. 8-9).

STEP 2 Diagram 1

Make a 2-⁵/₈" wide by 3-⁷/₈" high cutout in the desired control location. Do not oversize or under size the cutout.

STEP 3 Diagram 2

Route the control cable (provided with the control) from the wall cutout to the steam generator. Connect one end of the cable to the steam generator connector.

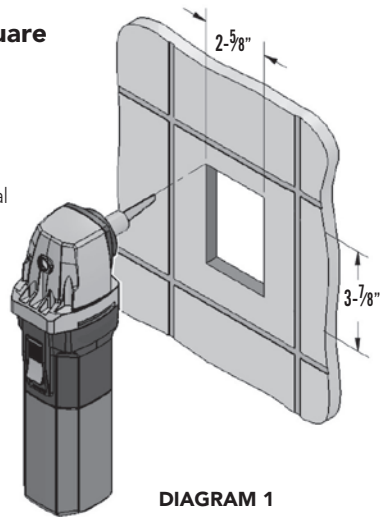

DIAGRAM 1

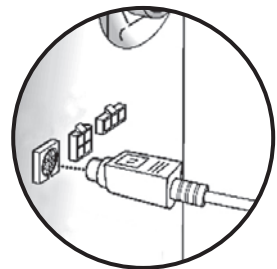

DIAGRAM 2

NOTE: The connector is keyed with the flat facing up. The control cable is the same at both ends.

IMPORTANT NOTE: Be careful not to strain, staple, pinch or otherwise damage the control cable. Route cable as required to permit replacement. Do not route cable inside conduit together with power lines or close to hot water or steam piping.

STEP 4 Diagram 3

Firmly connect the other end of the cable to the control. Turn on power to the steam generator and test the control to verify correct connections. Test per the instructions on pages 10-15. With verification of proper control function, proceed to Step 5.

CAUTION If the generator is on for more than a few minutes steam will start coming out of the steamhead. Insure that steam room is not occupied.

STEP 5 Diagram 4

Remove and discard peel-off paper to expose adhesive liner.

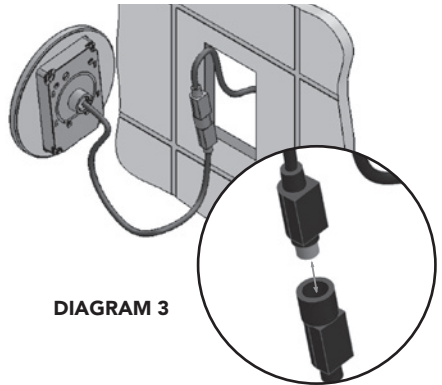

DIAGRAM 3

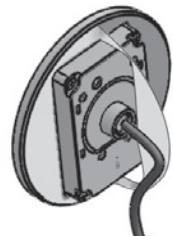

DIAGRAM 4

STEP 6 Diagram 5

Run a bead of silicone (provided) as shown to the outer edge of the control faceplate, following the contour of the circle or square shape. Use silicone as required to create a moisture seal.

NOTE: The silicone supplied by Mr. Steam can be used to meet a variety of sealing and gasketing. It cures to silicone rubber and adheres to glass, wood, metal, porcelain, ceramic tile, painted surfaces, many plastics and rubber. Surfaces must be clean and dry. Apply thin layer of product. Fit together and support if necessary. Allow excess material to cure, then trim with a sharp blade. Sealant “skins” in 5 minutes, dries to touch in 1 hour. Fully cures and bonds in 24 hrs.

IMPORTANT NOTE: Do not apply excessive amounts of silicone. Do not apply silicone to any other parts of the control including the adhesive gasket.

STEP 7 Diagram 6

Insure the mounting surface is clean and dry as required for good adhesion. Hold the control with the LED display in the 12 o'clock position and press the control against the wall until the adhesive sticks and holds firmly. Control may have to be supported or secured until the silicone fully cures and bonds.

DIAGRAM 5

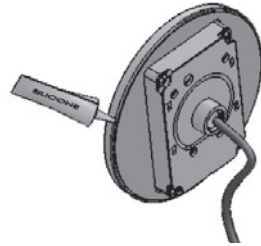

DIAGRAM 6



Installing the Remote Temperature Probe (PN: MST5)

The Remote Temperature Probe is required when the iTempo or TempoPlus Controls are installed outside the steam room.

⚠ CAUTION The Remote Temperature Probe (P/N MST5) is for use with iTempo and iTempoPlus Controls only. Do not use with any other controls. Do not use any other temperature probe with the iTempo and iTempoPlus controls. Noncompatible products may result in an inoperative control and a hazardous condition.

⚠ CAUTION Install the iTempo or iTempoPlus controls according to the installation instructions on pages 3-5. Failure to do so may result in an inoperative control and a hazardous condition.

1. Determine the location of the Remote Temperature Probe:

The Remote Temperature Probe must be installed:

- a. On a vertical surface
- b. 4-5 feet above the floor
- c. in a location representative of the desired steam bathing temperature. Locating the MST5 near the steamhead or near direct steam emissions may result in poor steam room temperature control.

- d. The probe has an integral 30' cable. Inure that the probe and/or steam generator are located accordingly.
2. Drill a 5/16 inch diameter hole in the wall. Do not oversize or under size the hole. Clean area thoroughly.

NOTE: The silicone supplied by Mr. Steam can be used to meet a variety of sealing and gasketing. It cures to silicone rubber and adheres to glass, wood, metal, porcelain, ceramic tile, painted surfaces, many plastics and rubber. Surfaces must be clean and dry. Apply thin layer of product. Fit together and support if necessary. Allow excess material to cure, then trim with a sharp blade. Sealant "skins" in 5 minutes, dries to touch in 1 hour. Fully cures and bonds in 24 hrs.

3. Remove the knock-out from the steam generator jacket as shown in Diagram 1.
4. Insert the probe cable through the knock-out and connect to the connector on the steam generator printed circuit board marked EXT TEMP as shown in Diagram 1.

DIAGRAM 1

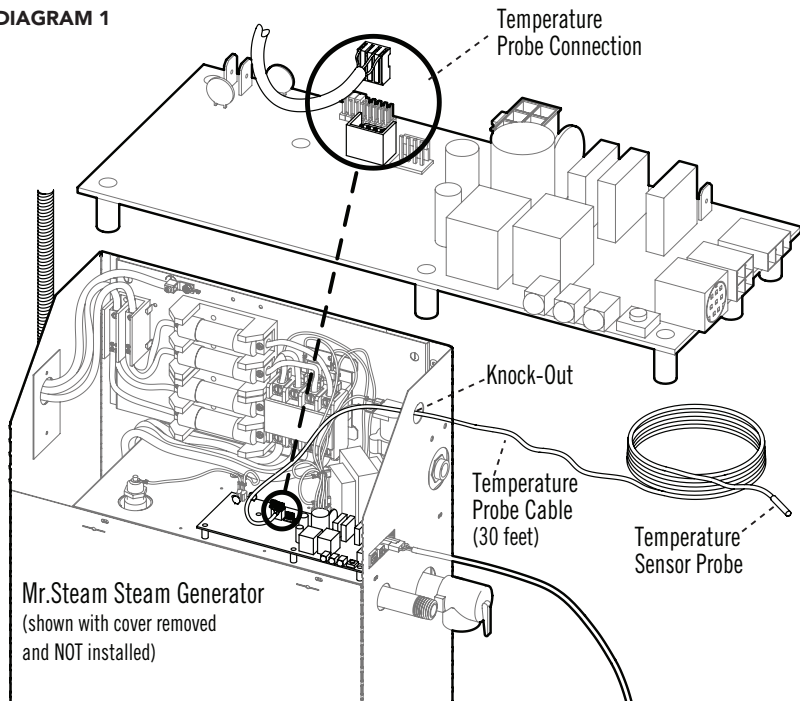

- Route the end of the probe cable with the temperature probe through the wall into the steam room as shown in Diagram 2.

IMPORTANT NOTE: Do not strain, staple, pinch or otherwise damage the probe cable.

- With a minimal length of the cable exposed inside the steam room, apply silicone (provided) to the hole in the wall as required to create a moisture seal as shown in Diagram 2.
- Push the temperature cable and probe into hole as required to leave minimum 1/4", maximum 1/2" of the bulb exposed as shown in Diagram 3.

⚠ WARNING Insure a minimum of 1/4" of the temperature probe is exposed to the air. Failure to do so may interfere with the ability to sense temperature and may result in excessive steam room temperatures.

⚠ WARNING The exposed area of the temperature probe must be free of silicone or any materials or obstructions that prevent direct exposure to the steam room air. Failure to do so may interfere with the ability to sense temperature and may result in excessive steam room temperatures.

NOTE: For Illustrative Purposes Only.
Drawings Not to Scale

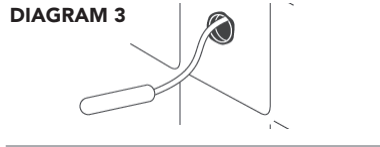
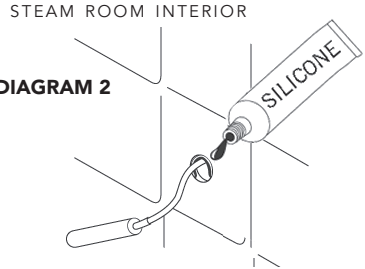

Sectional View

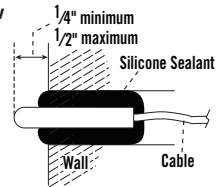

Installed Remote Temperature Probe

showing a minimum of 1/4" of the probe exposed to steam room air

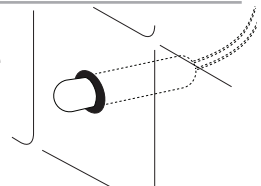

iTempo™ Operating Instructions

The iTempo Control features programmable digital temperature control, a fixed (60) minute duration, ON/OFF and PAUSE. The control can be set at a temperature range from 80°F up to 120°F

⚠ WARNING Set the steam bathing temperature according to personal preference, however it is highly recommended to begin steam bathing at a low temperature setting for a very short duration to gauge comfort and safety levels.

ON/OFF Diagram 1

Press the ON/OFF key to start or stop the flow of steam. Steam will begin to flow a few minutes after the control is turned ON. The duration required for the steam room to reach steam bathing temperatures depends on the steam room construction and steam generator specifications. Steam may continue to flow for a short time after the control is turned OFF.

PAUSE FEATURE Diagram 2

If a pause in steam flow is desired press the PAUSE key. The display will flash while the control is in the PAUSE mode. The timer will continue to countdown while in the PAUSE mode. Steam may continue to flow for a short time after pause is pressed.

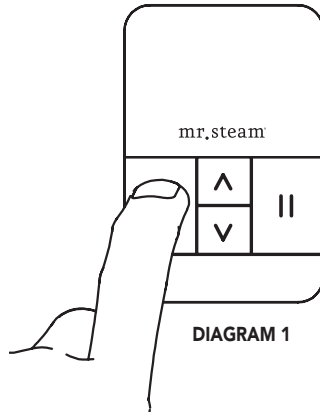

DIAGRAM 1

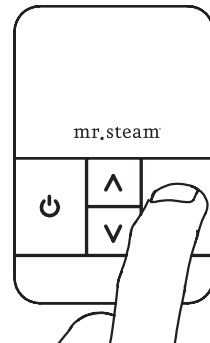

DIAGRAM 2

TIMER FEATURE

When the control is turned ON a 60 minute time duration is initiated. The control will turn off after 60 minutes unless the control is turned off manually.

MEMORY FEATURE

If the control is turned off manually before 60 minutes then the default temperature of 110°F will be used the next time the control is turned on. If the control times out at 60 minutes (not manually turned off) then the previous user temperature setting will be used when the steam-bath is used again.

SETTING THE TEMPERATURE

Diagram 3

The control is pre-set and will display the temperature setting of 110°F (default setting). Use the UP and DOWN keys to change the temperature setting from 80° F to 120° F in one degree increments.

CHANGING THE TEMPERATURE

UNITS (F°/C°) Diagram 4

When the generator is Off, Press and hold ON/OFF key for 10 seconds. The temperature units will be displayed as Fahrenheit (TuF) or Celsius (TuC). Use the UP/DOWN keys to choose between (TuF) and (TuC). Press ON/OFF key to accept the new units and exit.

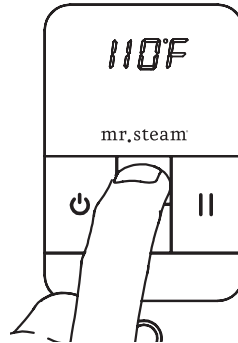

DIAGRAM 3

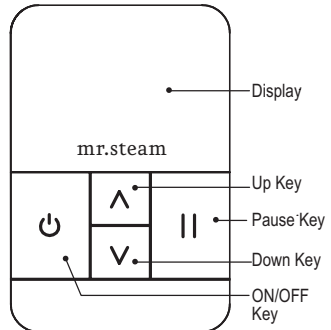

DIAGRAM 4

iTempoPlus™ Operating Instructions

The iTempoPlus Control features programmable temperature control, programmable time duration, clock, AromaSteam, ChromaSteam®, ON/OFF and two personal settings.

⚠ WARNING Set the steam bathing temperature according to personal preference, however it is highly recommended to begin steam bathing at a low temperature setting for a very short duration to gauge comfort and safety levels.

POWERING UP THE UNIT Diagram 1

When the generator is first powered up or after a power interruption, the clock display flashes and the clock is ready to be set up.

NOTE: Pressing the ON/OFF will start the generator even if the clock has not been set.

ON/OFF Diagram 2

Press the ON/OFF key to start or stop the flow of steam. The Temperature Set Point is displayed. Steam will begin to flow a few minutes after the control is turned ON. The duration required for the steam room to reach steam bathing temperatures depends on the steam room construction and steam generator specifications. Steam may continue to flow for a short time after the control is turned OFF.

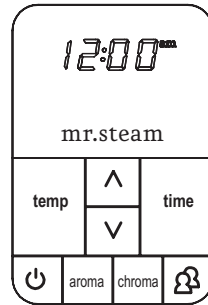

DIAGRAM 1

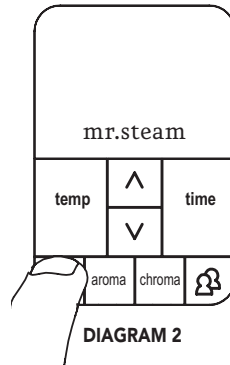

DIAGRAM 2

SETTING THE CLOCK Diagram 3

When the display is not flashing: Press and hold the TIME key until the display starts flashing.

Use the UP/DOWN keys to select the desired time, at this time the AM/PM logo will be displayed. Press the TIME key to save changes.

NOTE: The clock can only be set when the generator is off.

SETTING THE STEAMBATH DURATION

Diagram 4

Press TIME key to set or display the steambath duration time on the clock. The control is pre-set and will display a TIME setting of 20 minutes (default setting). With the TIME or CLOCK displayed, press the UP or DOWN keys (Diagram 5) to set the desired duration time (2-60 minutes) in two minute increments.

Set the steambath duration according to personal preference, however it is highly recommended to begin steam bathing at a very short duration to gauge comfort and safety levels. The control will turn off when the duration period times out. Then, the clock time will be displayed.

DIAGRAM 3

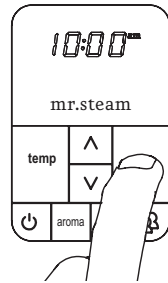

DIAGRAM 4

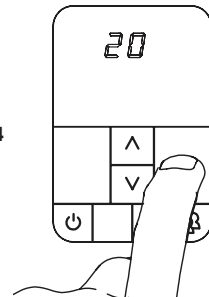
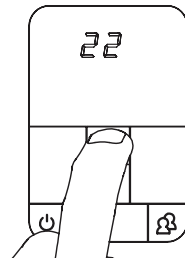

DIAGRAM 5



SETTING THE TEMPERATURE

Diagram 6: Press TEMP key to set the desired temperature or display the temperature setting.

Diagram 7: The control is preset and will display a temperature setting of 110°F (default setting). With the temperature displayed, press the UP or DOWN keys to set the desired temperature (80°F to 120°F) in one degree increments.

Set the steam bathing temperature according to personal preference, however it is highly recommended to begin steam bathing at a low temperature setting to gauge comfort and safety levels.

DIAGRAM 6

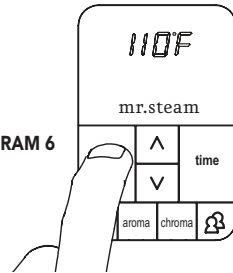

MEMORY FEATURE

If the control is turned off manually before it times out then the default settings of 20 minutes and 110°F will be used the next time the control is turned on. If the control times out (not manually turned off) then the previous user time and temperature settings will be used when the steambath is turned on.

DIAGRAM 7

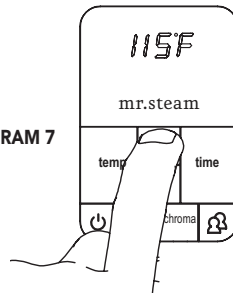

PROG 1 AND PROG 2

Diagram 8

Use the P1/P2 key program to store preferred settings.

To program preferred settings:

- Press ON/OFF key to turn generator on.
- Press P1/P2 key once to program PROG1.
- Press it twice to program PROG2. The selected parameter will be displayed. Enter the preferred time and temperature settings.

The iTempoPlus will store the following settings: set point, time duration & aroma state. To select PROG1 or PROG2:

- Press ON/OFF key then press P1/P2 key once to select PROG1, press it twice to select PROG2. The steambath will begin to operate at the stored settings.

DIAGRAM 8

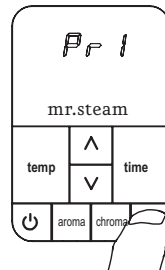

CHANGING THE TEMPERATURE UNITS

(°F/°C)

When the generator is Off, Press and hold ON/OFF key for 10 seconds. The temperature units will be displayed as Fahrenheit (TuF) or Celsius (TuC). Use the UP/DOWN keys to choose between (TuF) and (TuC). Press ON/OFF key to accept the new value and exit.

AROMASTEAM Diagram 9

The AromaSteam is an optional accessory that automatically injects aromatic oil into the steam. Press the ON/OFF key to turn the steam generator on. Then, press the AROMA key. The Aroma indicator will be displayed. The AromaSteam turns off automatically when the steam generator stops heating. Press the AROMA key to turn it off during a steam session. The indicator will turn off.

CHROMASTEAM® Diagram 10

The ChromaSteam is an optional accessory that provides colored light in the steam room. Press the CHROMA key to turn light on. Press twice to select the next color. Press again to turn the light off. Note that the light can be turned ON even if the steam generator is OFF.

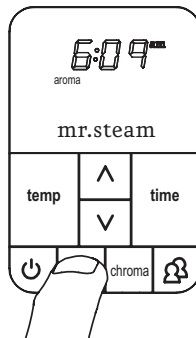

DIAGRAM 9

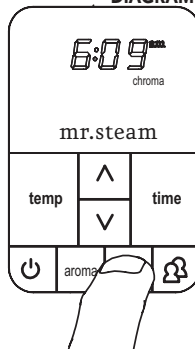
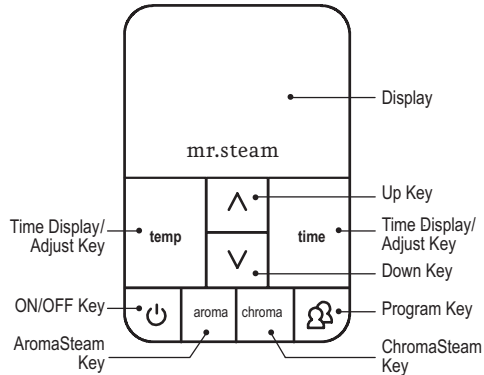

DIAGRAM 10



Care Tips for all Controls and Steamheads

1. Use only mild soap and water on a soft cloth to clean the control and steamhead.
2. Do not use abrasive cleansers
3. If the decorative cover is damaged on the iTempo™ or iTempoPlus™ call Mr.Steam® technical service for replacement parts.

NOTE: Replacement of the decorative covers requires removal and reinstallation of the control from the mounting surfaces.

Warranty

To register your steam generator unit online and to review the Mr.Steam Limited Lifetime Warranty please go to:

blog.mrsteam.com/wr



TEMPLATE FOR CONTROL INSTALLATION (SEE PG.6)

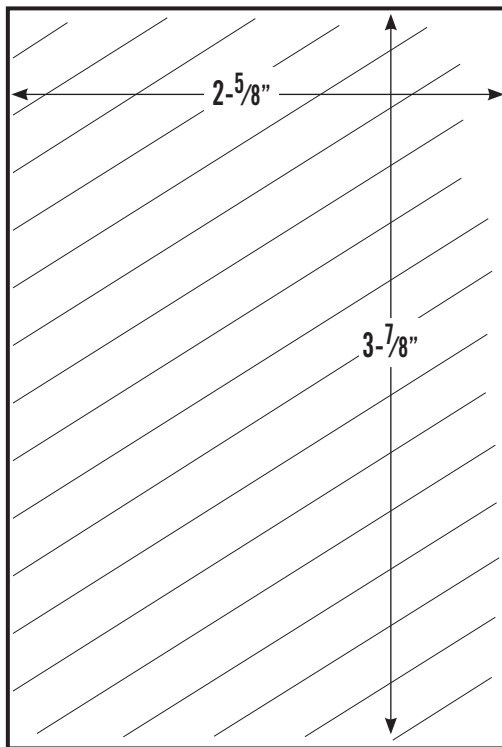

mr.steam®

Feel Good Inc.

Products, information and specifications are subject to change without notice.

For more information call Sales & Support at:
1.800.76.STEAM (East Coast) 1.800.72.STEAM (West Coast)

2015 © Sussman-Automatic Corporation. Mr.Steam and des., AromaFlo, AutoFlush, AutoSteam, Butler Package, ChromaSteam, Clean Steam...Every Time, Club Therapy, Digital 1, Express Steam, From Bathroom to Spa, iDream Package, iGenie, iSizing, iSteam, MusicTherapy, Spa Package, Steam@Home, Steam Therapy, Sussman, Valet Package, Virtual Spa System, Voice Genie and Voice Wizard are registered trademarks of Sussman-Automatic Corporation. AudioWizard, HomeWizard, iButler, iTempo, iTempoPlus, Smart Sizing, SteamStart, The Intelligent Steambath are trademarks of Sussman-Automatic Corporation.

100474 REV. 6.15